



We produce the best enclosure systems

Posts and Accessories

Posts and fixing systems
for welded fencing

TP

Calle Edison, nº1. Pol. Ind. Can Estella.
08635 Sant Esteve Sesrovires. Barcelona. Spain.
Tel: (00 34) 93 771 55 41
tecnomallas@tecnomallas.com
www.tecnomallas.com

Posts and accessories compatible with all chain-link fencing

Tecnomallas Quality

All Tecnomallas posts are made with Sendzimir Z-275 galvanised steel and meet all the European covering, strength and sturdiness standards. The different models of posts and their corresponding fixture systems are made of long-lasting metal or injection moulded plastic and resist the elements. They are compatible with all chain-link fencing and ensure a sturdy connection with quick and easy installation.

Materials and Finishes

All the posts are made from galvanised steel with a Zinc Z-275 covering in accordance with standards UNE-EN 10204-3.1, UNE-EN 10305-5, UNE-EN 10219-1/2 and UNE-EN 10142. A heat-strengthened, environmentally-friendly polyester covering is applied during lamination (lead and resin-free) which has received at least a 120-micra anti-rust treatment.

Galvanised post details

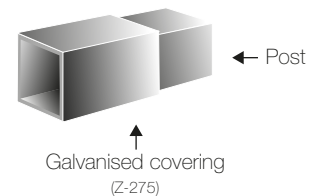

Qualities of the Laminated Polyester:

Pre-cleaning processes by degreasing, phosphating, ecological passivation and washing with pH-neutral water.

- Shine (ISO 2813) = angle 60:95%
- Adherence (ISO 2409) = GTO
- Buchholz hardness (UNE 48252) = 80

Galvanised and laminated plastic post details

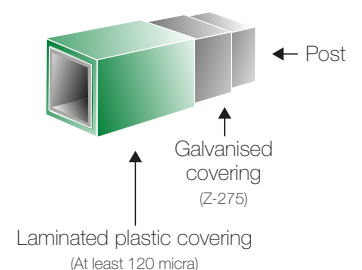

Standard Colours



















Special Colours

Any colour on the RAL Colour Chart can be chosen.



Posts and Accessories

	1 Rectangular post	2 Square post	3 Tecnopost system	4 Europost system	5 Ecopost system	6 Chain-link post
Biblock PVC clamp 	●					
Tecnofix PVC fastener 		●				
60 x 40 metal clamp 	●					
60 x 60 metal clamp 		●				
Tecnoclip 			●			
Euroclip A fastener 				●		
Euroclip B fastener 				●		
Euroclip fastener plate 					●	
Cremaclip fastener 						●
Aluminium platen 	●	●				
Tecnopost platen 			●			
Europost platen 				●		●
Iron platen 	●	●	●	●	●	
Galvanised steel plate 			●			
Bayonet 						●
Single and double aluminium elbows 						

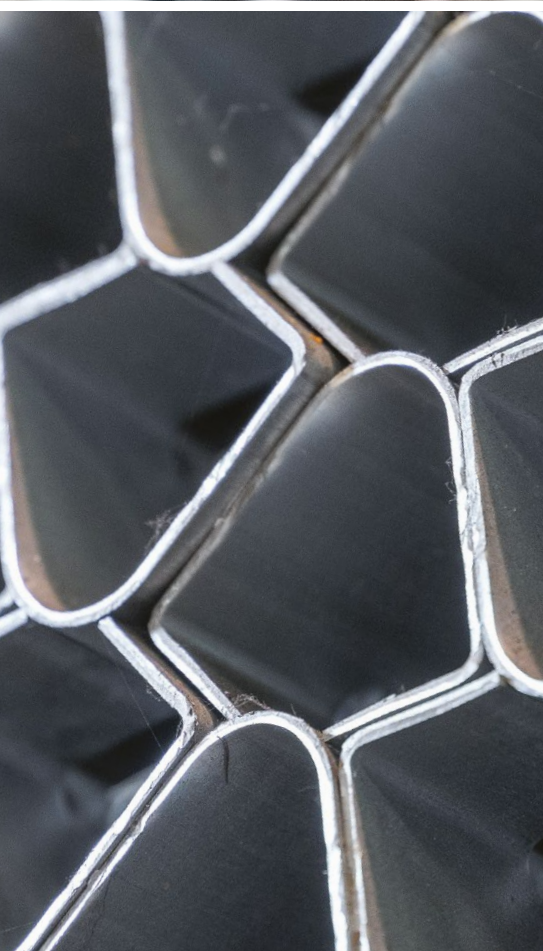



1

60 x 40 mm Rectangular Post

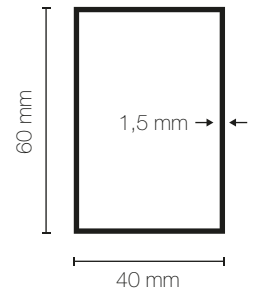

The 60 x 40 mm rectangular post is made with 1.5 mm-thick Z-275 galvanised steel.

Its metal clamps and Biblock PVC allow for a high degree of versatility and strength in a quick and easy installation. They are located below the panel supports for greater efficiency, except from the last panel, where they are located above.



Flat fence connection

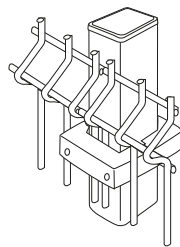

Fence connection at an angle (up to 90°)

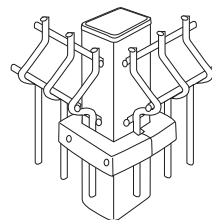

Fence connection on a slope

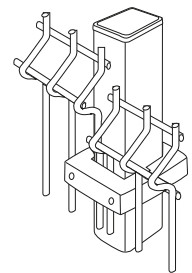

Dimensions

Post height	Upper cover	Upper cover	No. of clamps
625	900	1	2
825	900	1	2
1.025	1.300	1	2
1.225	1.500	1	3
1.525	1.800	1	3
2.025	2.350	1	4
2.425	3.000	1	4

*All dimensions in mm.
Other special dimensions available on request.*



60 x 40 metal clamp

The 1.5 mm-thick metal clamp quickly, safely and efficiently connects the post to the panel. It can be laminated in plastic of any colour on the RAL Colour Chart.



60 x 40 Biblock PVC Clamp

The Biblock system consists of two pieces of injection moulded plastic with high resistance to the elements. The nuts inserted throughout allow for quick and easy installation.

The screws are hidden and protected by plastic covers.



The inner gripping membranes of the clamp attach to the panel rod and hold it firmly in place to prevent the panel from falling or moving.



Accessories and complements

Upper cover



The cover is aesthetic and protective, as it stops the entry of water into the post.

Aluminium Platen



The platen fixes the post in the ground without the need to make holes and without the risk of rusting.

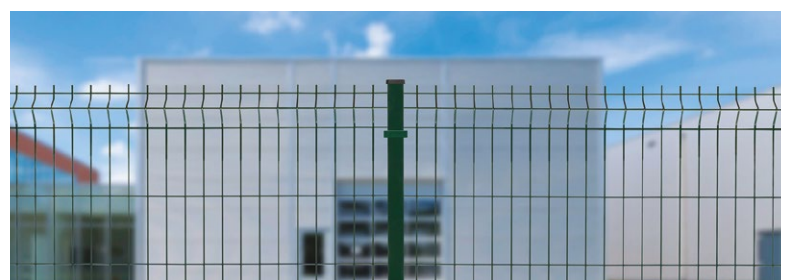



2

60 x 60 mm Square Post

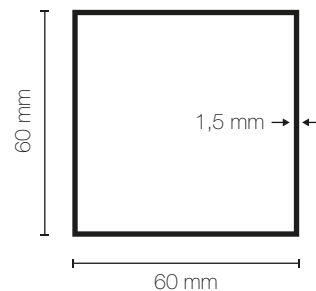

The square post is made with 1.5 mm-thick Z-275 galvanised steel. As it has a larger perimeter, it offers more sturdiness during installation.

The panel is fixed to the post by means of a simple and practical self-drilling screw that allows the metal fastener to be positioned at the desired height.

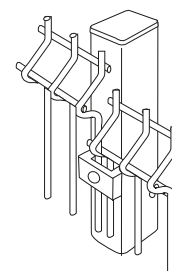
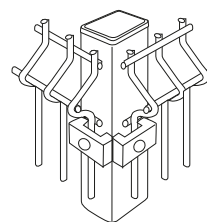
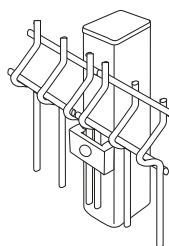

Dimensions

Post height	Upper cover	Upper cover	No. of clamps
625	900	1	2
825	900	1	2
1.025	1.300	1	2
1.225	1.500	1	3
1.525	1.800	1	3
2.025	2.350	1	4
2.425	3.000	1	4

*All dimensions in mm.
Other special dimensions available on request.*





60 x 60 metal clamp

This fastener consists of a single piece of 1.5 mm-thick metal to strengthen the post. It may be laminated in plastic of any colour on the RAL Colour Chart.

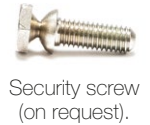

60 x 60 Tecnofix PVC Fastener

This piece of injection moulded plastic with high resistance to the elements connects the chain-link fence to the post by means of a self-drilling screw which is hidden and protected by a plastic cover.



Flat fence connection

Fence connection at an angle (up to 90°)

Fence connection on a slope

Complements

Upper cover



The cover is aesthetic and protective, as it stops the entry of water into the post.

Galvanised Platen



The galvanised platen welded to the post is ideal for fixing to walls and concrete surfaces without the need for installation.





3

Tecnopost Post

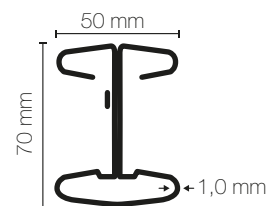

The large perimeter of this H-shaped post gives it great strength and consistency, making it ideal for enclosures of great height. It fits any type of panel, with or without a window. It allows for quick, easy and comfortable installation as it does not have external fixing accessories.

Dimensions

Post height	Upper cover
625	900
825	900
1.025	1.300
1.225	1.500
1.525	1.800
1.725	2.000
1.825	2.300
1.925	2.300
2.025	2.500
2.225	2.700
2.4v	3.000

All dimensions in mm.
Other special dimensions available on request.

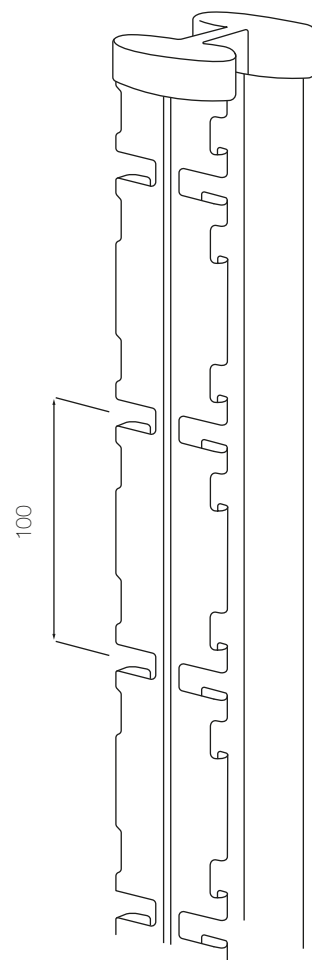

Properties

- Sendzimir Z-275 galvanised steel.
- Complies with standard EN-10327.
- Thickness 1.00 mm (I/V 5.52 cm³).
- Tensile strength 300 to 400 N/mm².

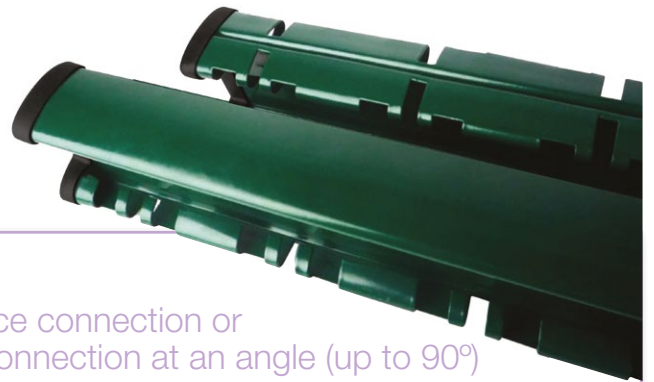

1. Flat fence connection or fence connection at an angle (up to 90°)



2. No accessories



3. Accessories and complements

Post Anchorage Platen



Ideal for fixing to walls and concrete surfaces.

Bayonet



With three rows for barbed wire, it strengthens security and has a strong deterrent effect.

Tecnoclip



This piece makes installation as quick and easy as possible.





4

Europost® Post

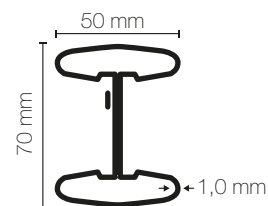

The consistency and appearance of this post make it ideal for large enclosures and its sturdiness allows for the installation of concealment sheets. Its fixing accessories permit tailor-made installation, as they can be placed in any position on the pole depending on the terrain.

Dimensions

Post height	Upper cover
625	900
825	900
1.025	1.300
1.225	1.500
1.525	1.800
1.725	2.000
1.825	2.300
1.925	2.300
2.025	2.500
2.225	2.700
2.425	3.000

*All dimensions in mm.
Other special dimensions available
on request.*

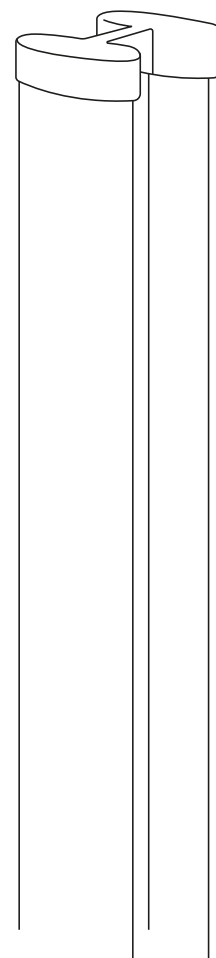

Properties

- Sendzimir Z-275 galvanised steel.
- Complies with standard EN-10327.
- Thickness 1.00 mm (I/V 5.97 cm³).
- Tensile strength 300 to 400 N/mm².



4



Flat fence connection



Fence connection with Euroclip A.



Fence connection with Euroclip B.

Accessories and complements

A

Post Anchorage Platen



Ideal for fixing to walls and concrete surfaces.

Drill Screwdriver



Its use speeds up and reduces installation.

Euroclip A



Manufactured in galvanized galvanized sheet of 3.00 mm. thick. Quality DX51 Z-275. Guarantees resistance to oxidation.

NEW

B

Post Anchorage Platen



Ideal for fixing to walls and concrete surfaces.

Lever



Essential to securely place the lateral accessories.

Euroclip B



Made with a 1.5 mm ferritic stainless-steel sheet to guarantee pressure and rust resistance.

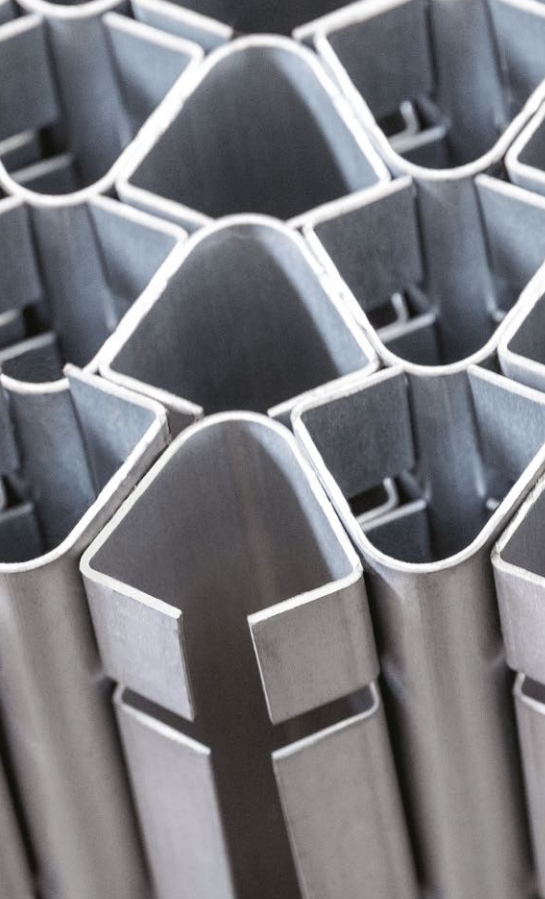

5

Ecopost[®] Post

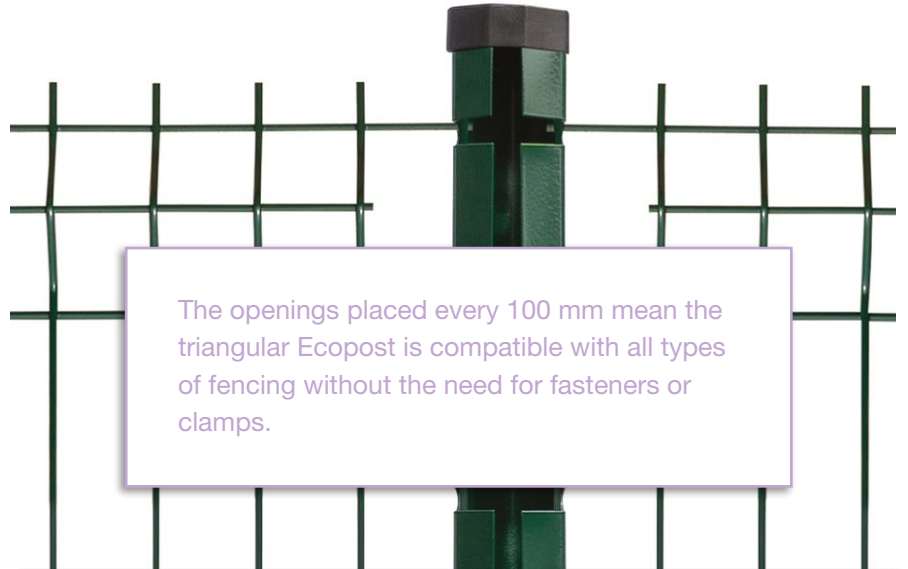
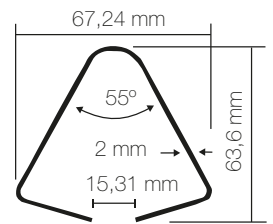

The openings placed every 100 mm mean the triangular Ecopost is compatible with all types of fencing without the need for fasteners or clamps.

Easy and Versatile Installation

The arrangement of the openings allows for a post-fence connection without the need for external accessories. There are just a few small metal pieces to speed up installation.

Flat fence connection

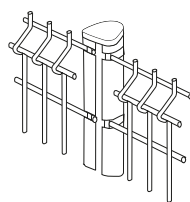

Fence connection on a slope at an angle (up to 180°)

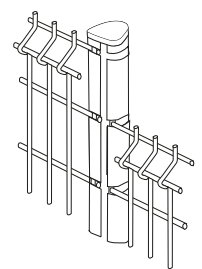
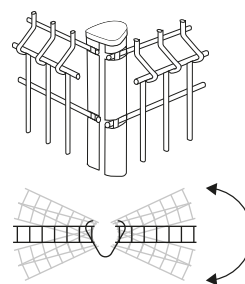

Dimensions

Post height	Upper cover
625	900
1.025	1.300
1.225	1.500
1.525	1.800
1.725	2.000
2.025	2.300

*All dimensions in mm.
Other special dimensions available
on request.*

Both openings allow for quick, easy and comfortable post-fence-post installation.

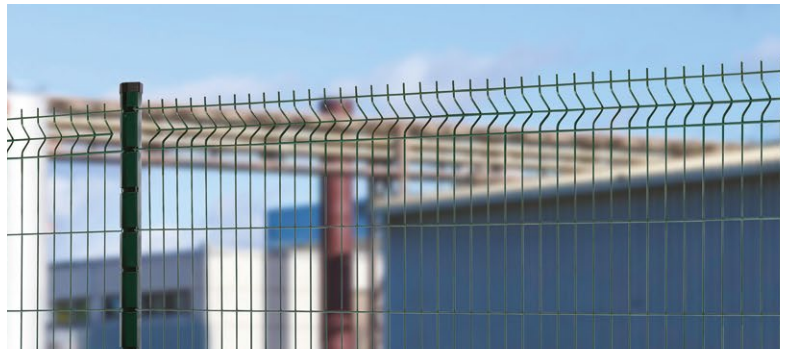

Accessories and complements

Upper cover



The cover is aesthetic and protective, as it stops the entry of water into the post.

Ecoclip



Located inside the post for maximum ease and speed during installation.



6

Chain-Link Post

48 mm Ø 80 mm Ø

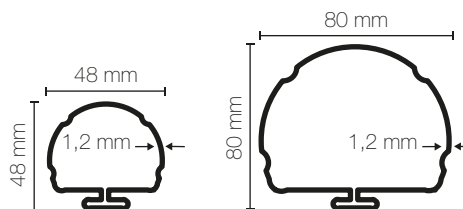

Thanks to its chain-link system, this 48 x 80 mm post makes it possible to place accessories along its length according to the needs of the installation. It can also be used for welded and twisted fencing.

Easy and Versatile Installation

The option of placing accessories along the length of the post makes the system very versatile and it can be adapted to all slopes and angles as necessary.

Flat fence connection

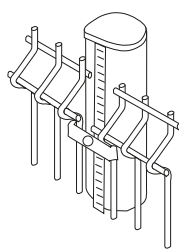

Fence connection at an angle (up to 270°)

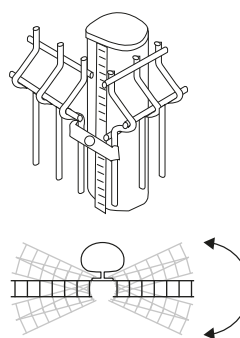

Fence connection on a slope

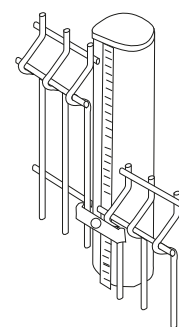

Dimensions

Post height	Upper cover
625	900
825	900
1.025	1.300
1.225	1.500
1.525	1.800
2.025	2.350
2.425	3.000

*All dimensions in mm.
Other special dimensions available on request.*



Cremaclip fastener

This fastener consists of two metal sections that clamp the fence securely to the post. They can be laminated in plastic of any colour on the RAL Colour Chart.



48 ø curved post (bayonet)

This bayonet post uses the same fastener system and its curved extension allows for more security of the enclosure by adding barbed wire.



Accessories and complements

Upper cover



The cover is aesthetic and protective, as it stops the entry of water into the post.

Aluminium Platen



48 ø or 80 ø and fixes the post in the ground without the need to make holes and without the risk of rusting.

Single and Double Bayonet Elbows



Located in the upper part of the 80 ø post, they give the exact angle for the defensive bayonet.

